

EN2  
EN4

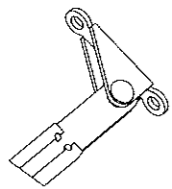

EN3

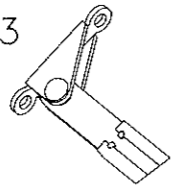

EN	W (mm)	Max (kg)
2	<850	<40
3	<950	<60
4	<1100	<80

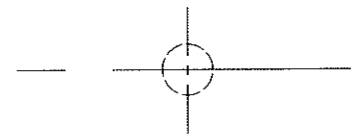
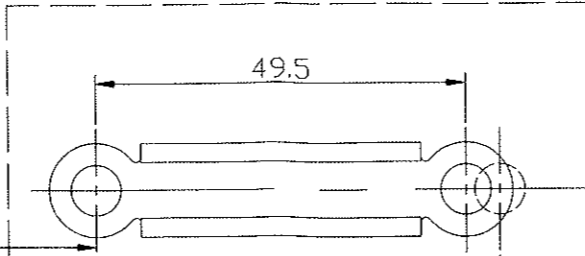

183 (EN2 & EN3)

237 (EN4)

1

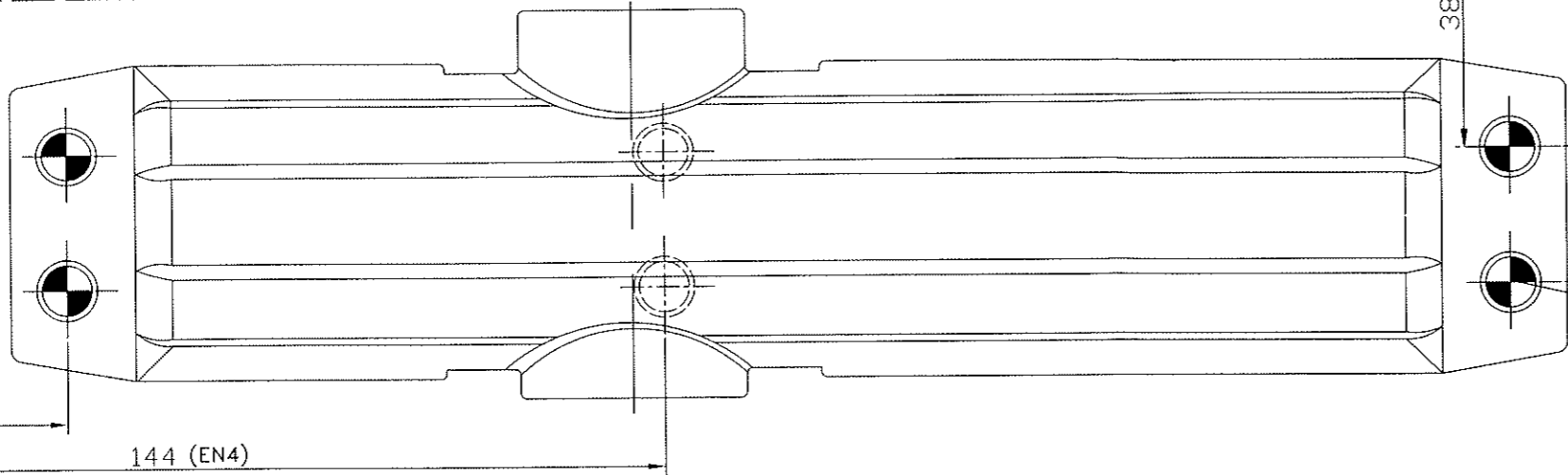

ø2.5	ø4.2
	M5

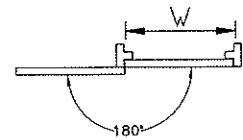
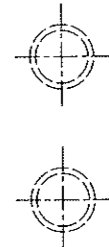

60 (EN2 & EN3)

144 (EN4)

